

CONTACT

Europe

CYBEX GmbH
Riedingerstr. 18
95448 Bayreuth
Germany
+49 (0) 921-78 511 - 0
info@cybex-online.com

Japan

Cybex Industrial Ltd.
Room 2001, 20/F
Two Chinachem Exchange Square
338 King's Road, North Point, Hong Kong
+81 30 5456 5225
info@cybex-japan.com

Americas

Columbus Trading-Partners USA Inc.
560 Harrison Avenue, Suite 500
Boston, MA 02118, USA
Customer Service 1-877-242-5676
orders.us@columbustp.com

Australia

CNP Brands
20 Calarco Drive, VIC, 3030
Australia
Customer Service 1300 667 137
info@cnpbrands.com.au

New Zealand

Wainhouse Distribution,
2-6 Argyle St, Morningside, PO Box 41-014,
St Lukes, Auckland, New Zealand
Customer Service 0800 567 5000
helpline@wainhousedist.co.nz



www.cybex-online.com



MIOS FRAME & SEAT

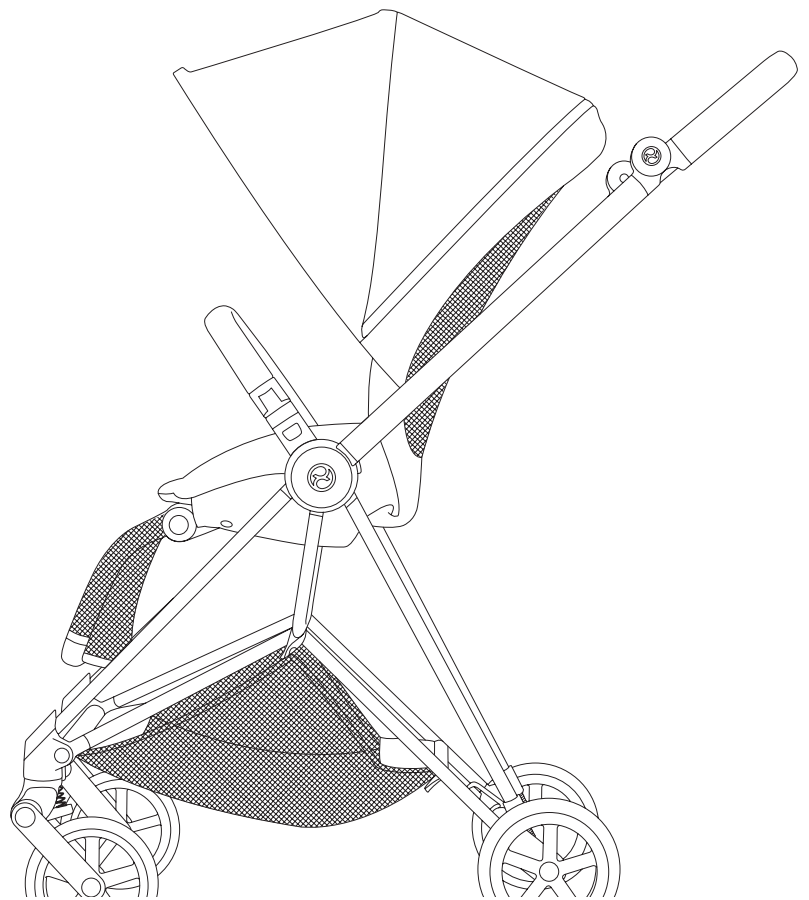

EN



Preparing the Mios

10



Using the XXL sun canopy (optional)

17



Using the bumper bar

18



Using the brake

19



Adjusting the handle bar

20



Adjusting the seat position

21



Adjusting the leg rest

22



Using the harness system

23



Free-standing position







27

2



Compact fold

29

	Using the swivel locks	29
	Removing the wheels	30
	Using the rain cover	31
	Attaching the infant car seat	32
	Attaching the carry cot	34
	Removing the fabric	35

DE



Vorbereitung des Mios

10



Verwendung des XXL Sonnendachs (optional)

17



Verwendung des Schutzbügels

18



Benutzung der Bremse

19



Einstellen des Schiebegriffs

20



Einstellen der Rückenlehne

21



Einstellen der Beinauflage

22



Verwendung des Gurtsystems

23



Selbststehende Position







27

4



Kompakte Position

29

	Feststellen der Vorderräder	29
	Entfernen der Räder	30
	Verwendung des Regenverdecks	31
	Anbringen der Babyschale	32
	Anbringen des Kinderwagenaufsatzes	34
	Abnehmen der Bezüge	35

FR



Préparation du Mios

10



Utilisation du canopy pare-soleil XXL (optionnel)

17



Utilisation du garde-corps

18



Utilisation du frein

19



Réglage du guidon

20



Réglage du dossier

21



Réglage du repose-pieds

22



Utilisation du harnais

23



Position debout







27



Pliage compact

29

6

	Utilisation du verrou de rotation	29
	Retrait des roues	30
	Utilisation de l'habillage pluie	31
	Installation des adaptateurs pour coque	32
	Attacher la nacelle	34
	Retirer la housse du Siège Luxe	35

ES



Preparar el Mios

10



Uso de la capota XXL (opcional)

17



Uso de la barra apoyabrazos

18



Uso del freno

19



Ajuste del manillar

20



Ajuste del respaldo

21



Ajuste del reposapiés

22



Uso del sistema de arneses

23



Posición de pie libre







27

8



Pliegue compacto

29

	Uso del bloqueo de dirección de las ruedas delanteras	29
	Extracción de las ruedas	30
	Uso de la burbuja de lluvia	31
	Colocación del adaptador del portabebés	32
	Adaptación del capazo	34
	Retirar la vestidura del Mios	35

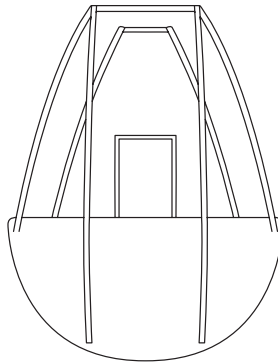
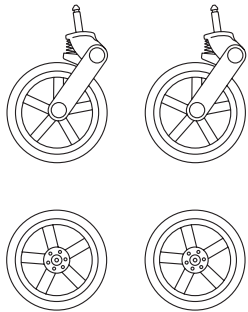
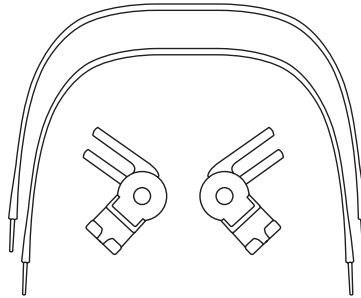
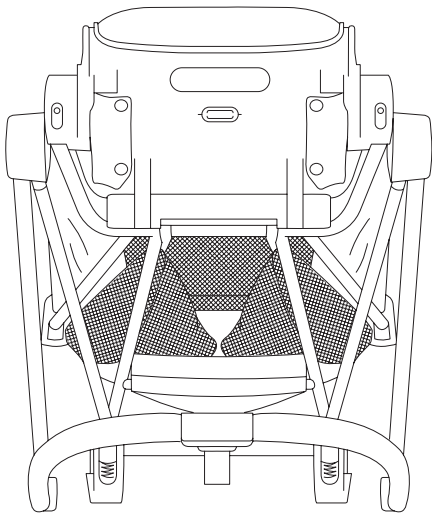

OPTIONAL

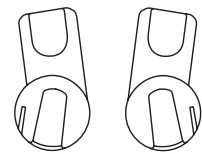



MIOS CARRY COT

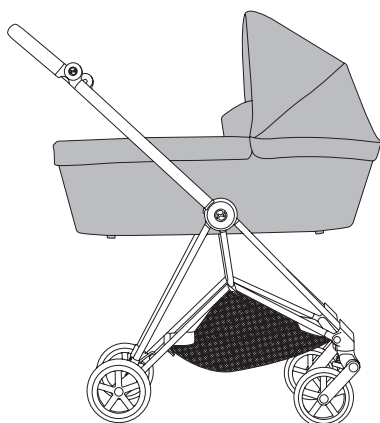

MIOS COLOR PACK

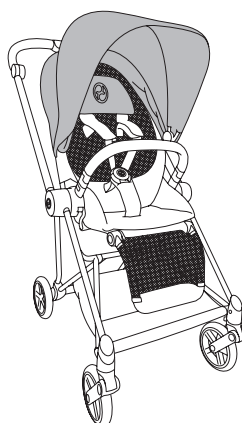

MIOS COMFORT INLAY

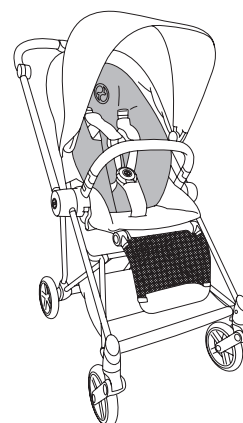

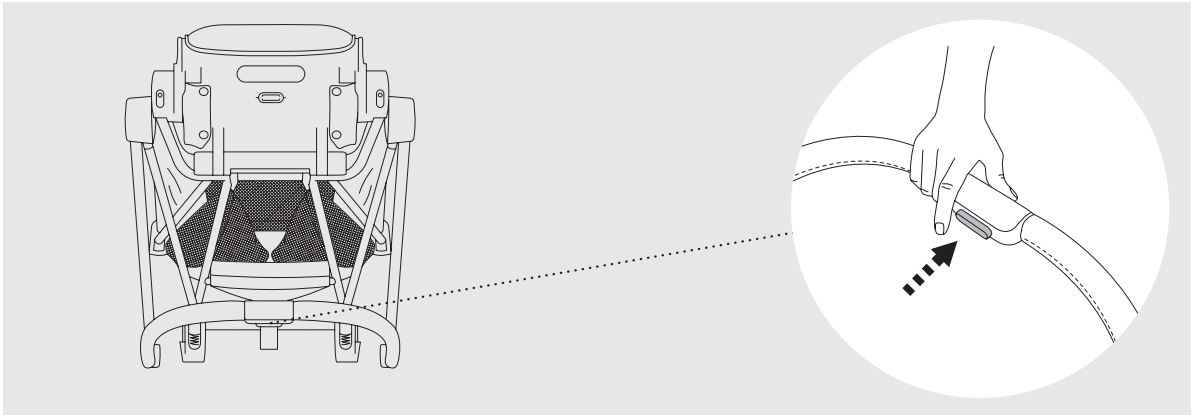

1

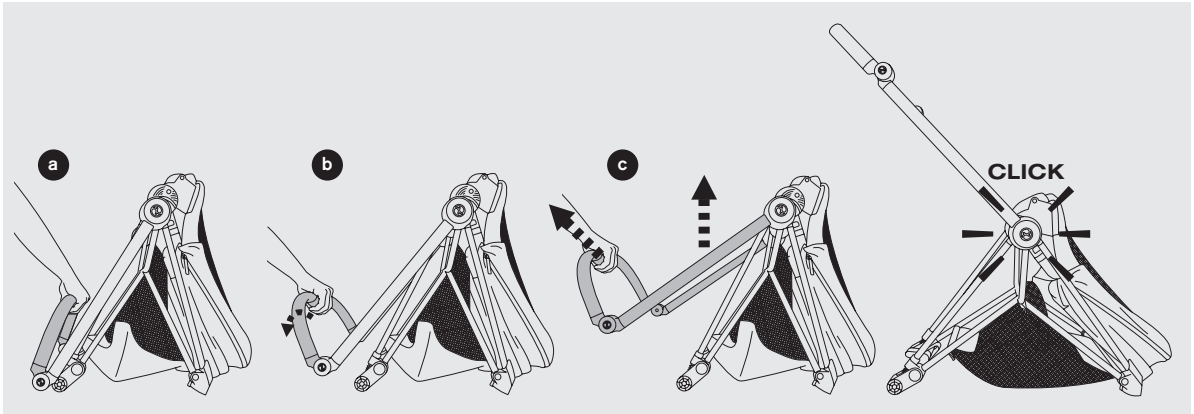

12

2

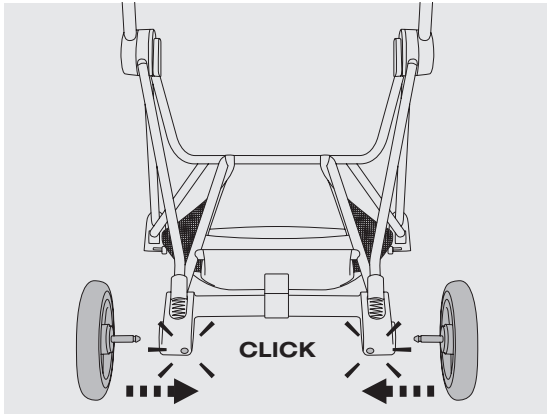

3

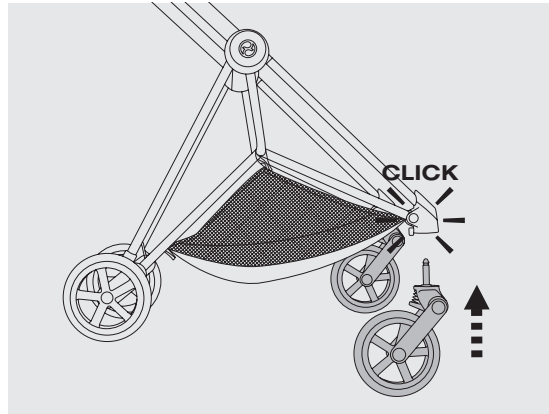

4

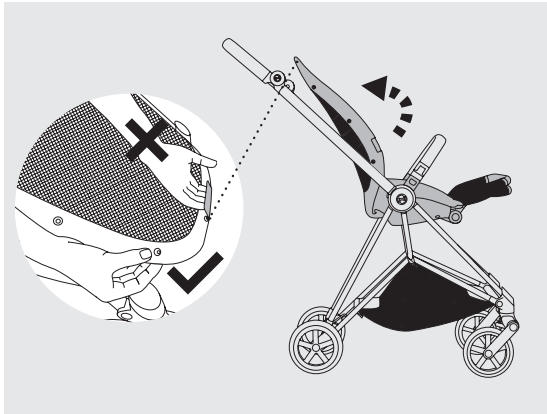

5

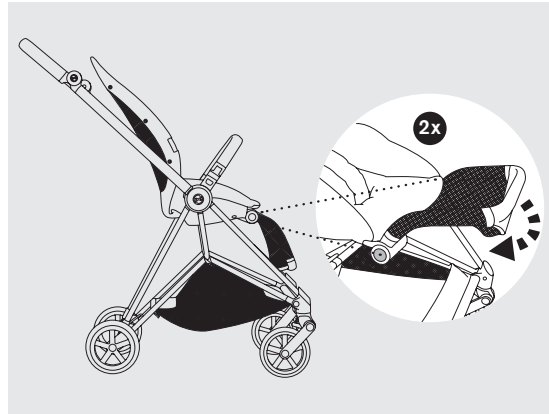

6

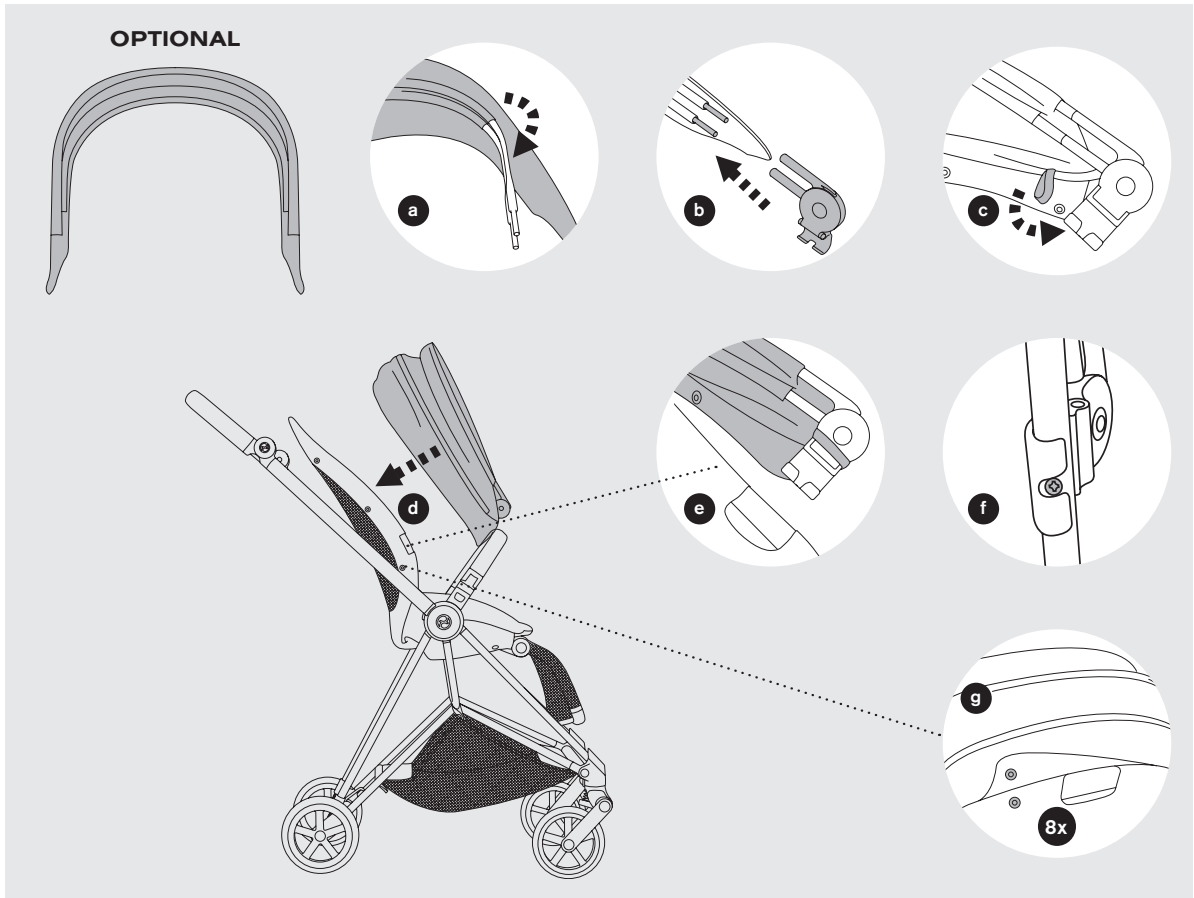

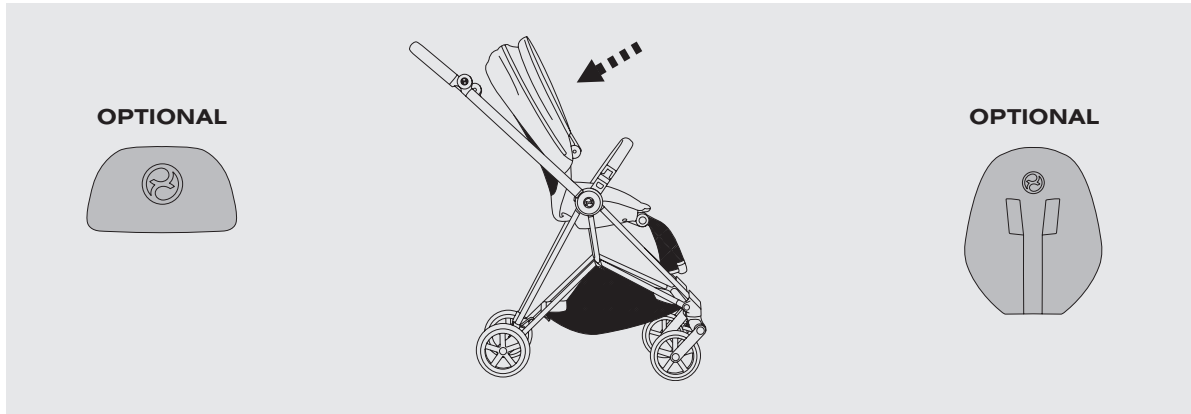

8

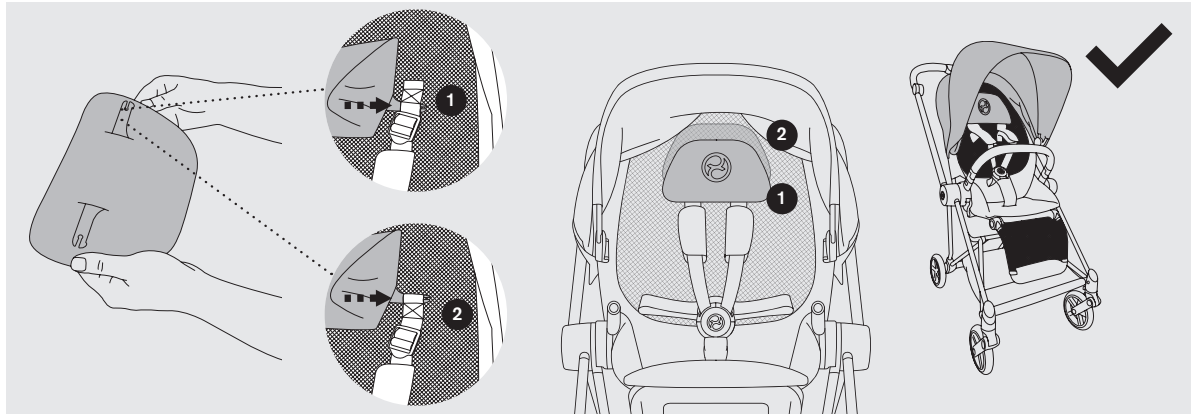

9

15

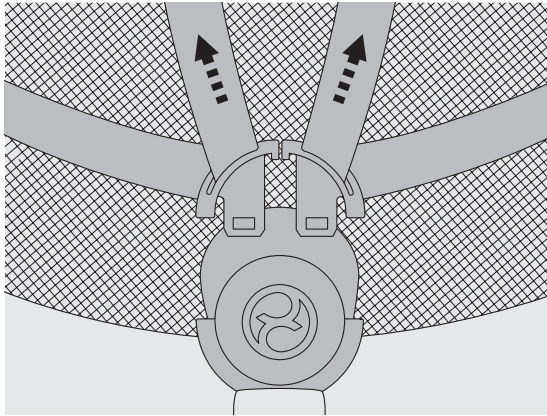

10

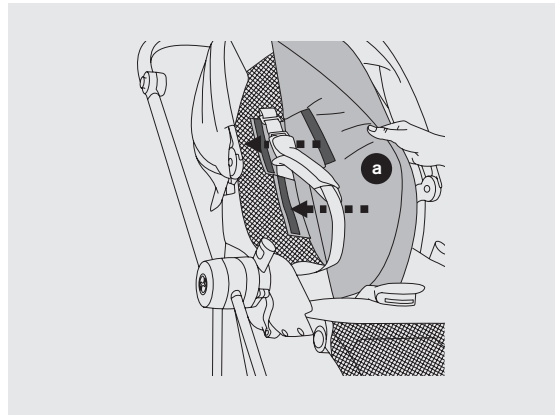

11

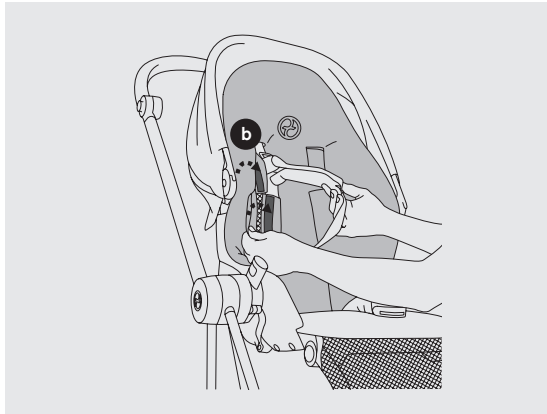

12



13

16

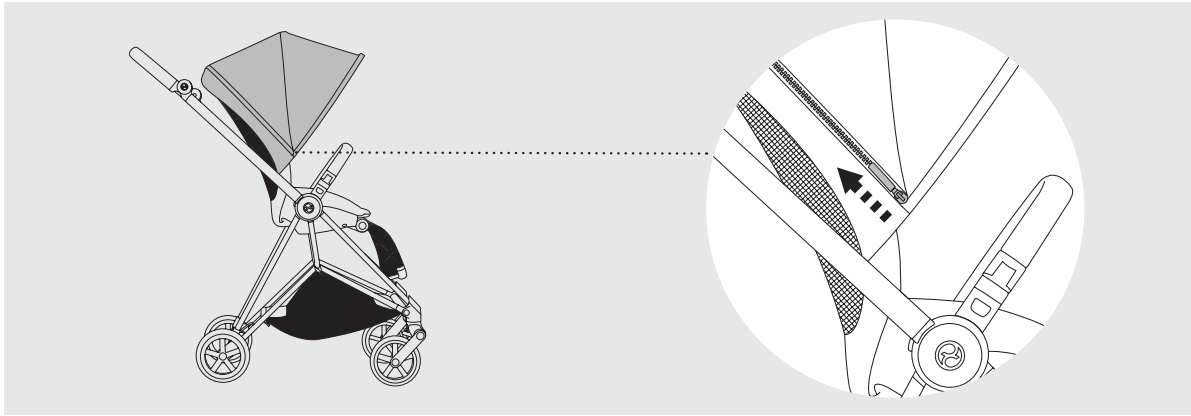

1



2

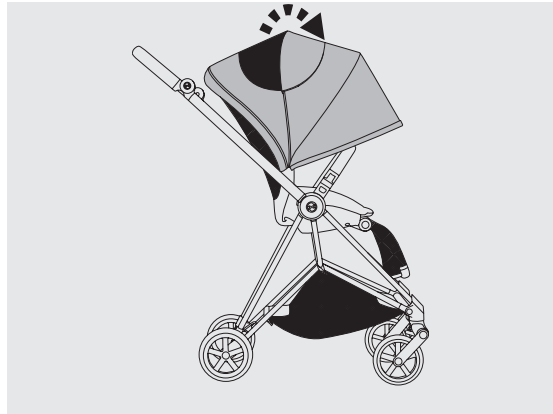

3

17

⌋

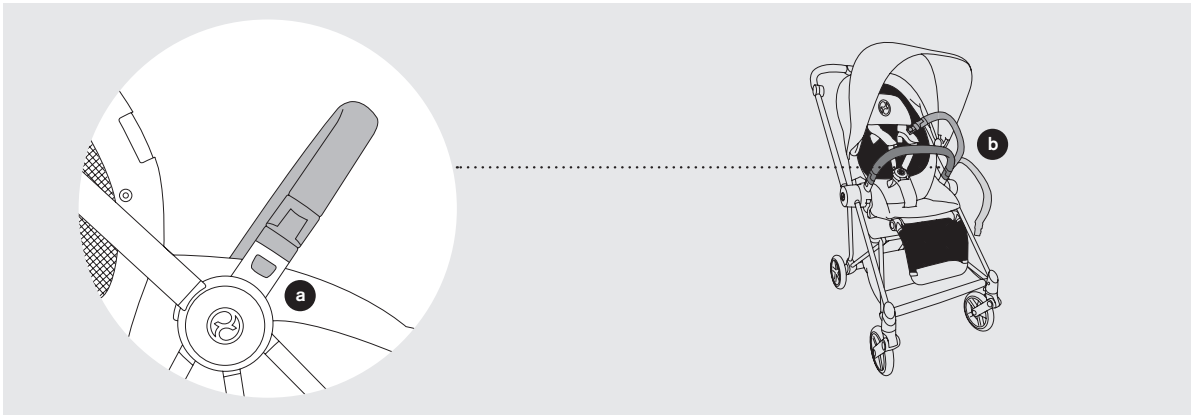

1

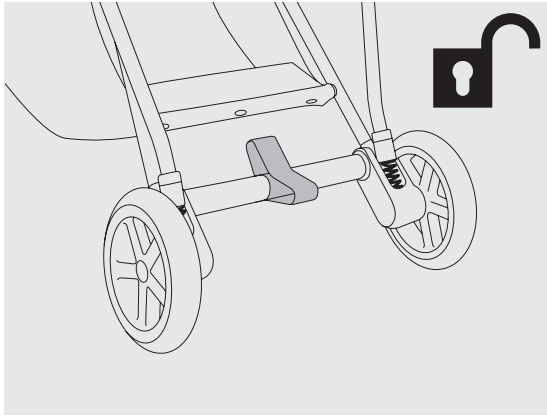

1

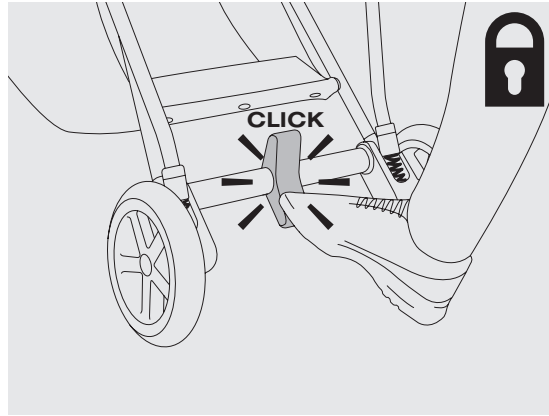

2

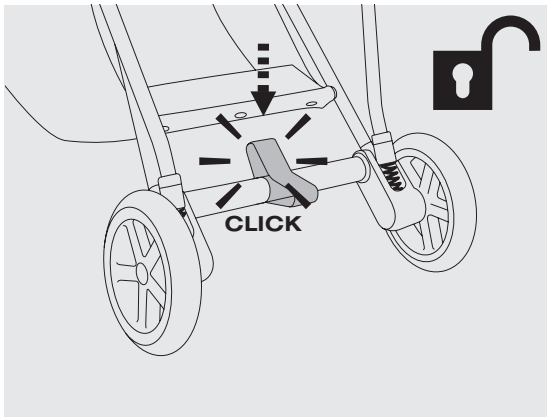

3

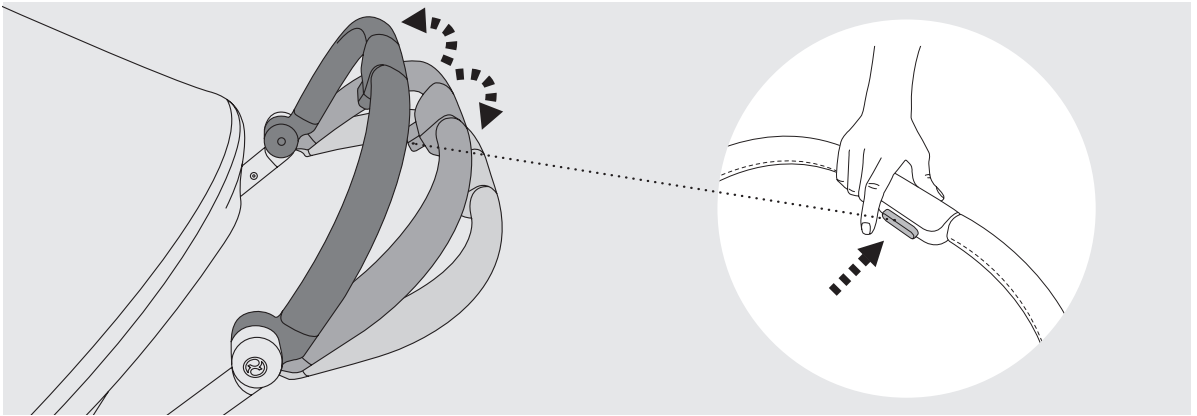

1

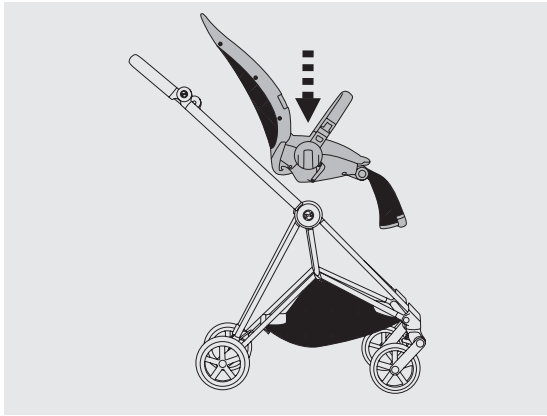

1

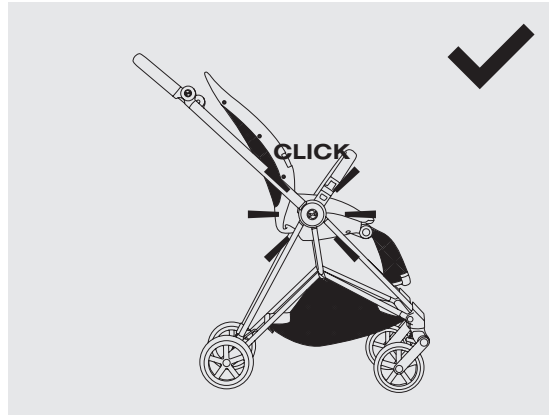

2

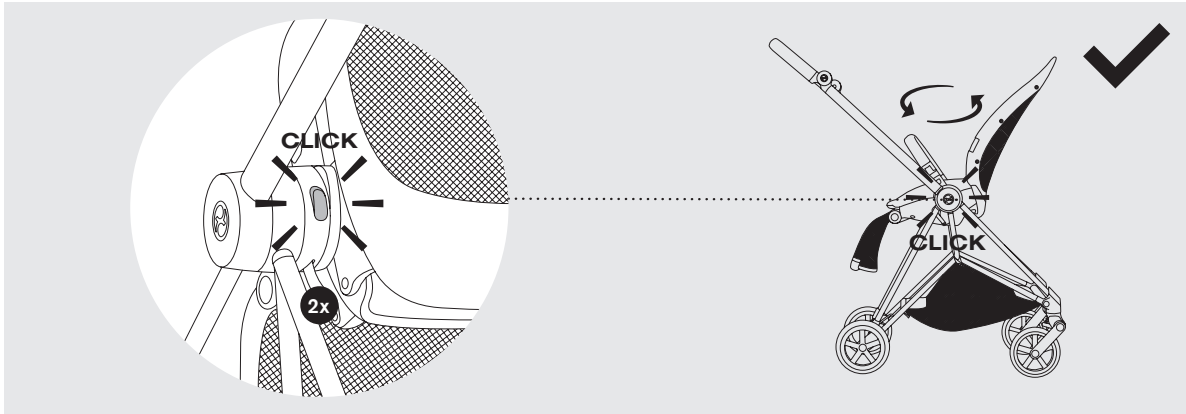

3

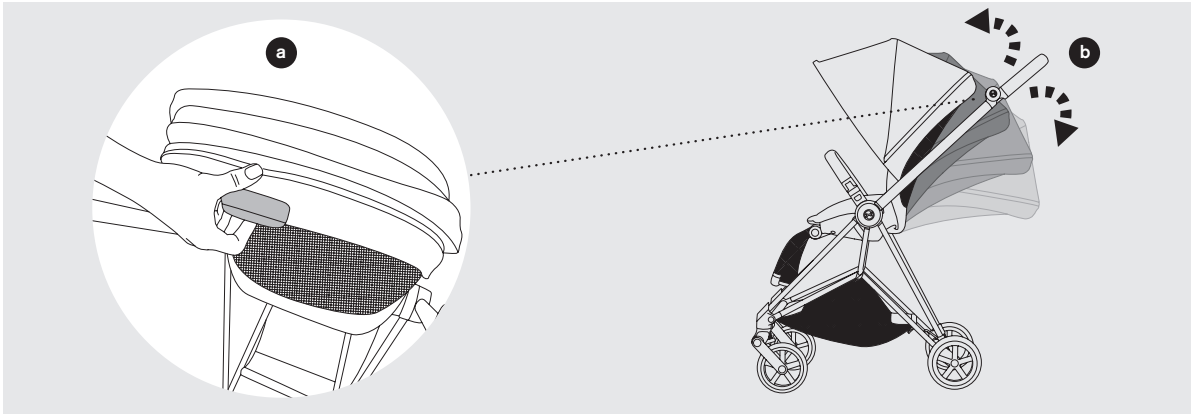

4

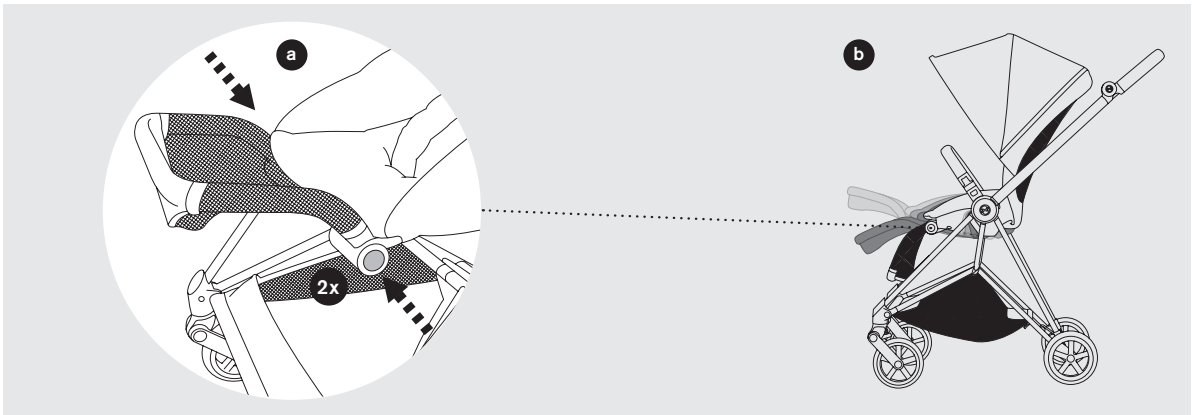

22

1

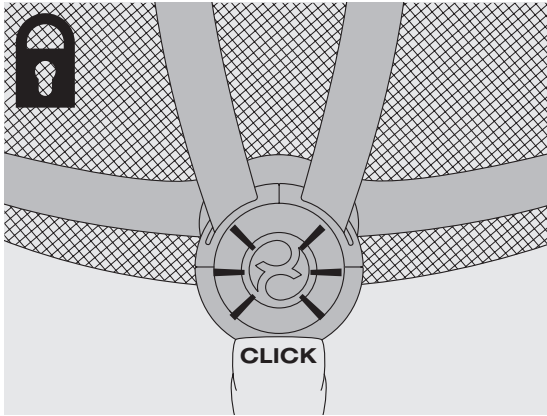

1

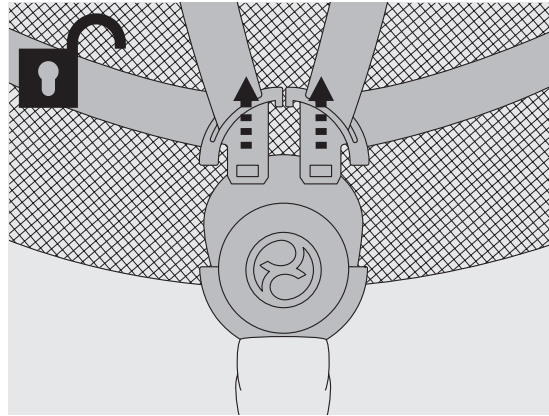

2

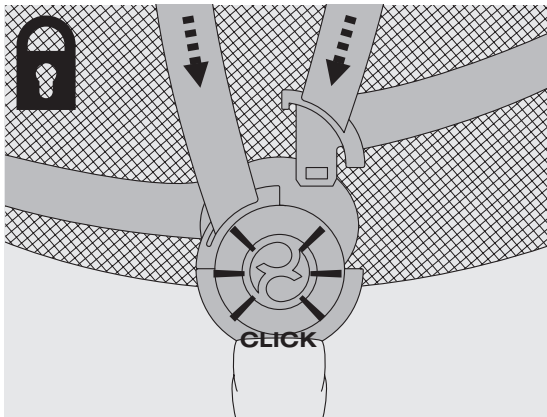

3



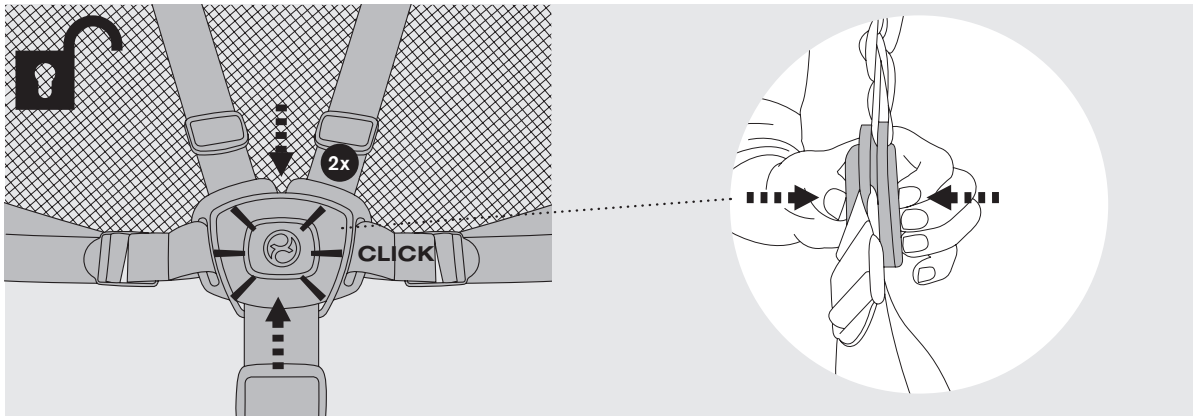

1

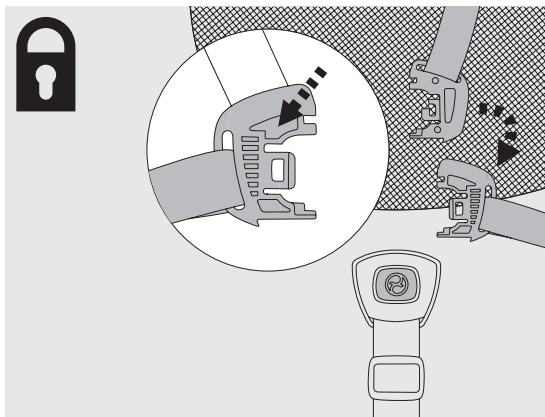

2

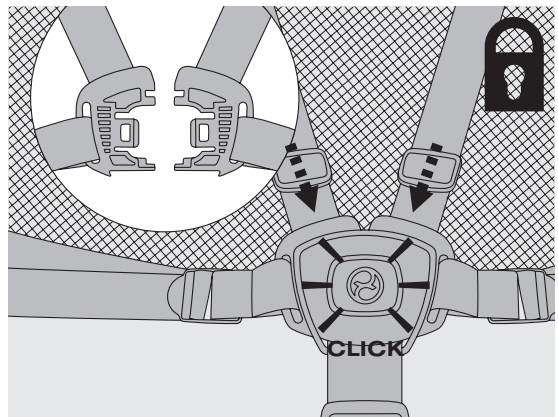

3

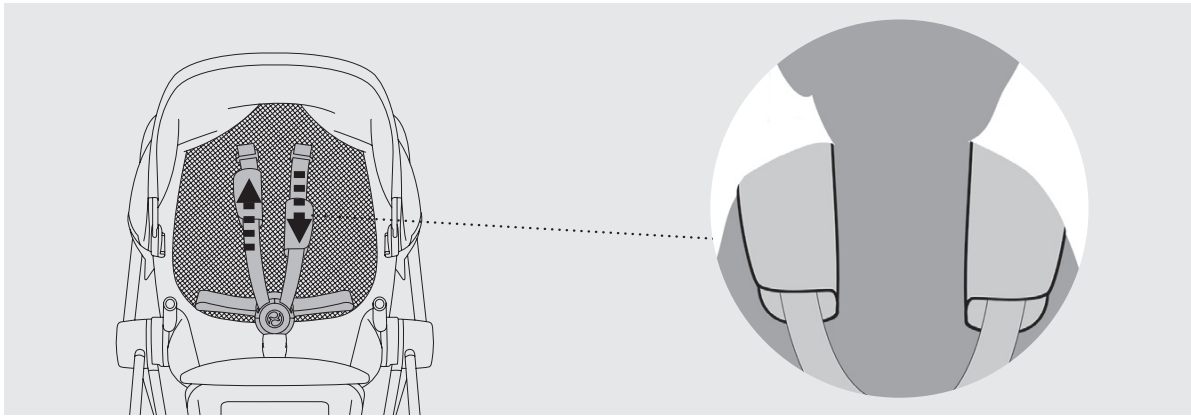

1

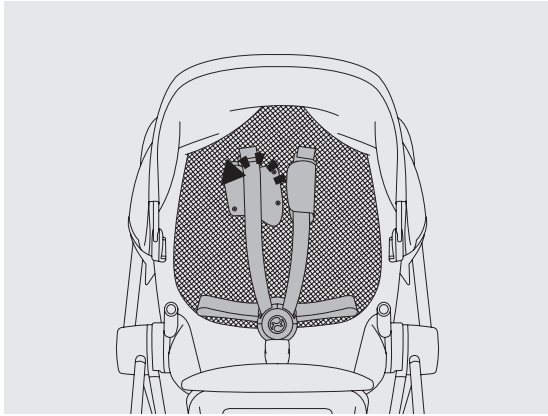

2

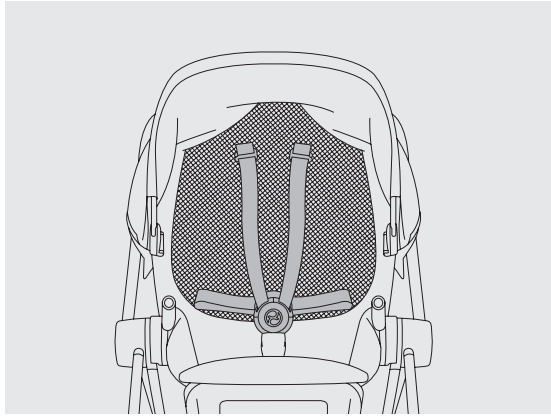

3



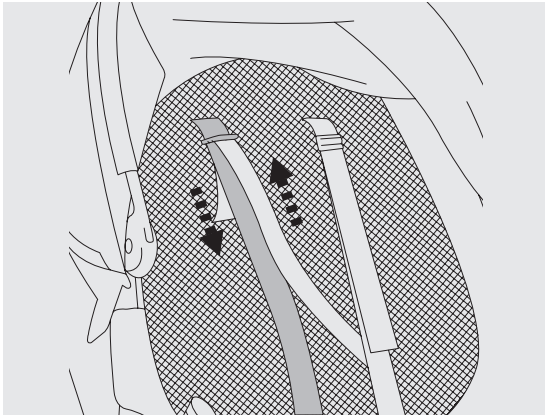

4

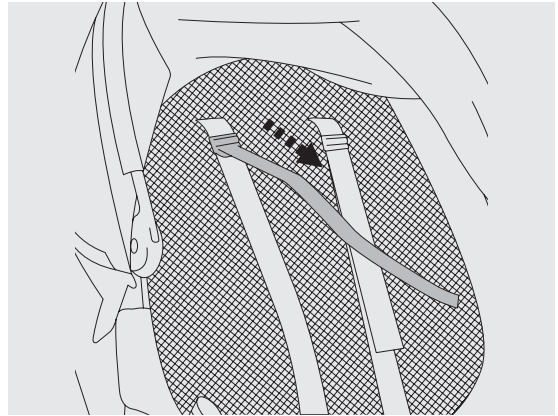

5

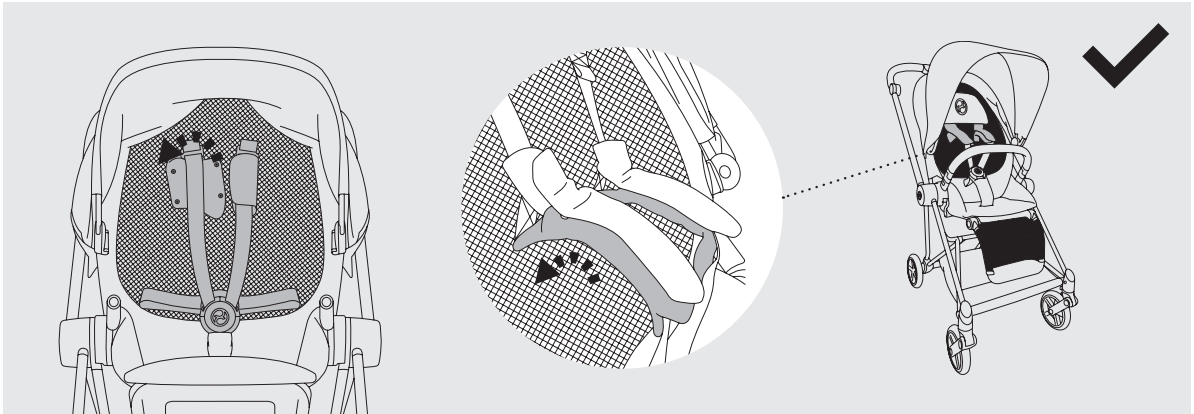

6

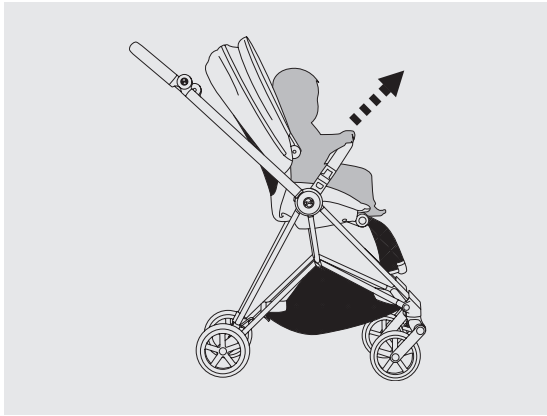

7

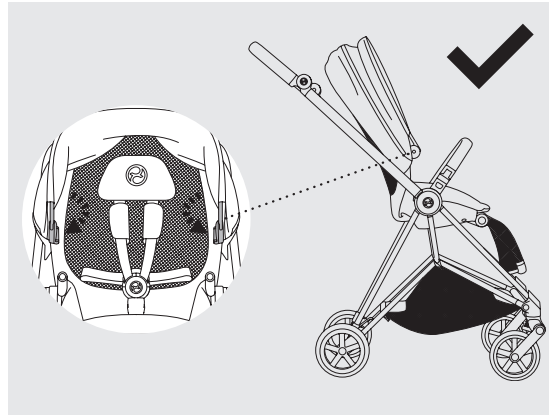

8

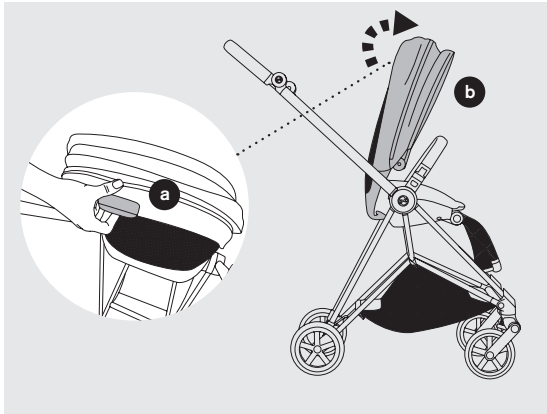

9

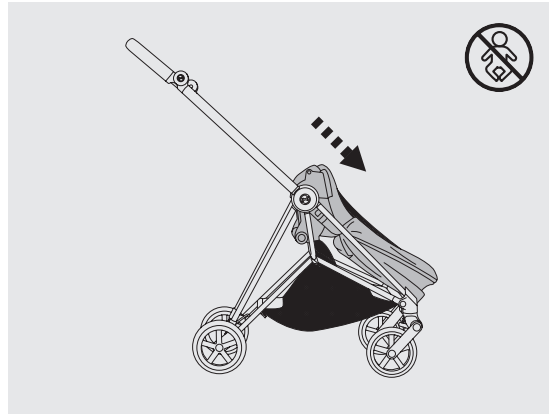

10

27

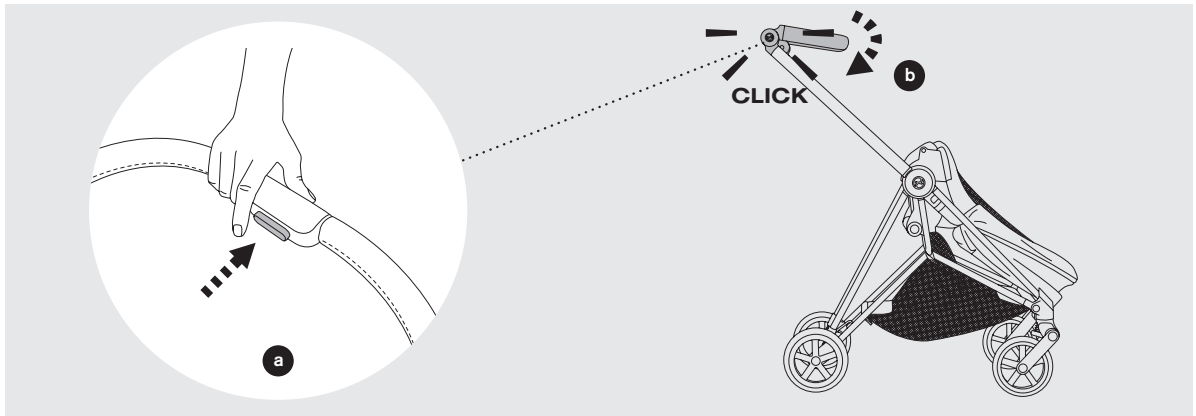

1

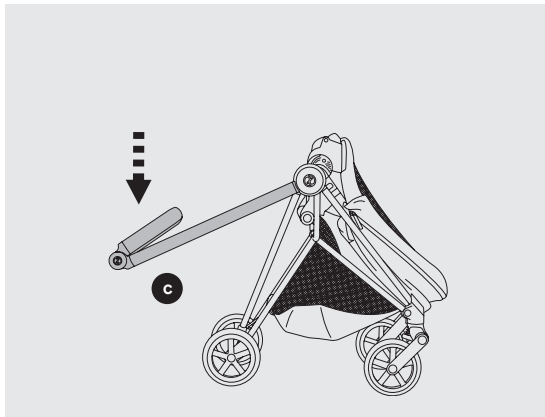

2



3

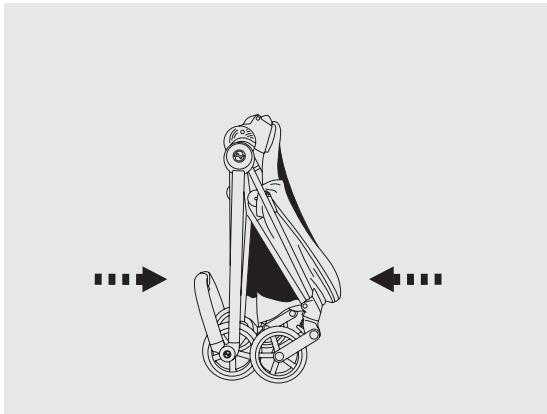

1

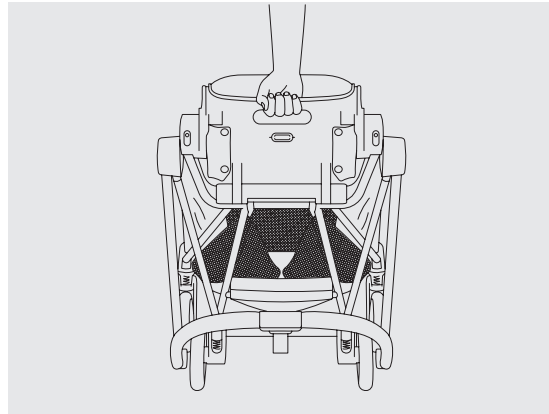

2

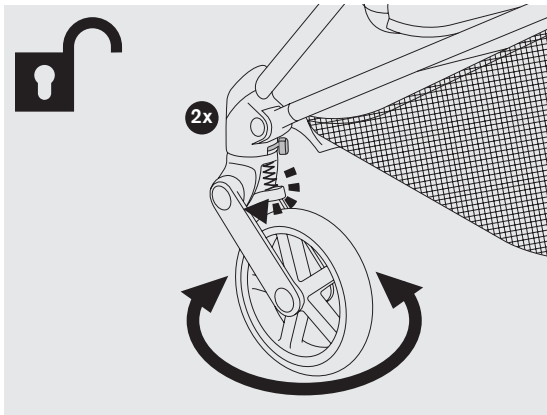

1

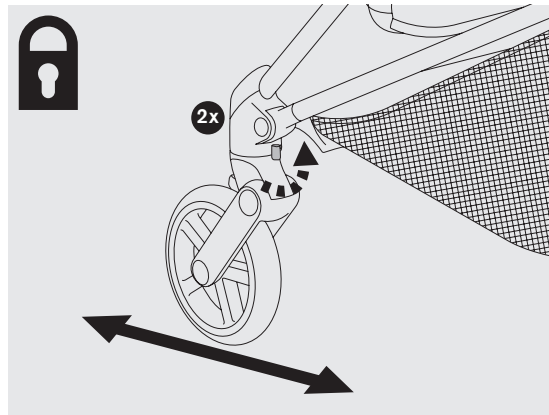

2



29

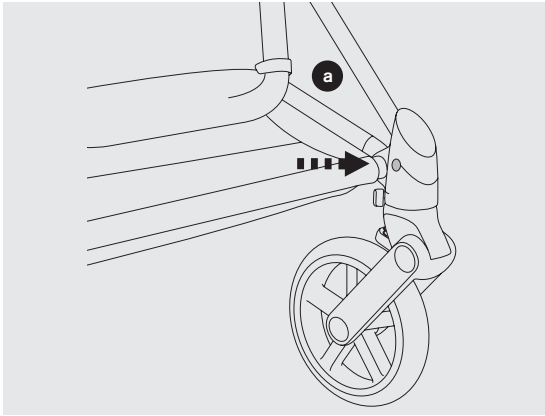

1

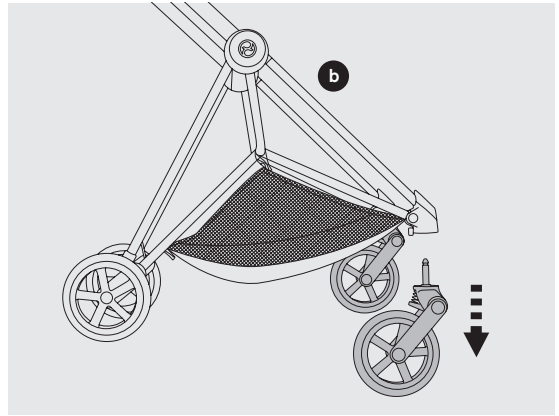

2

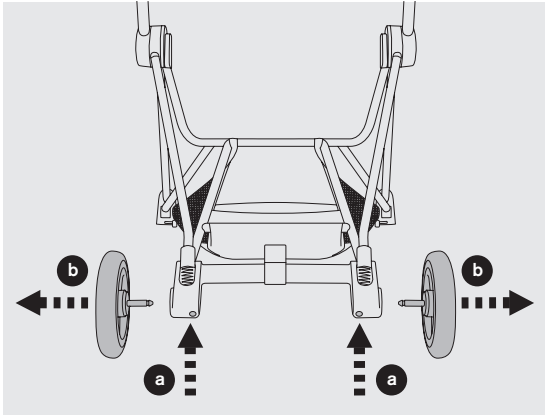

3



1

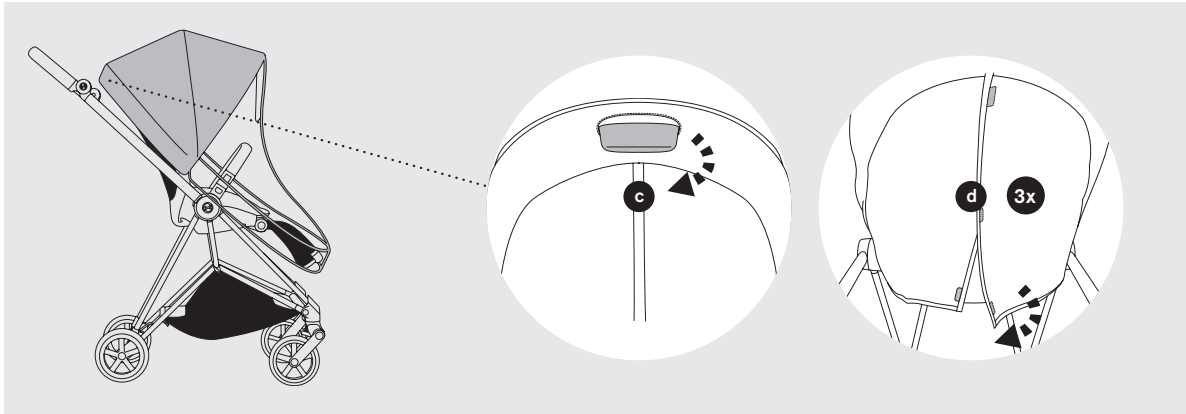

2

31

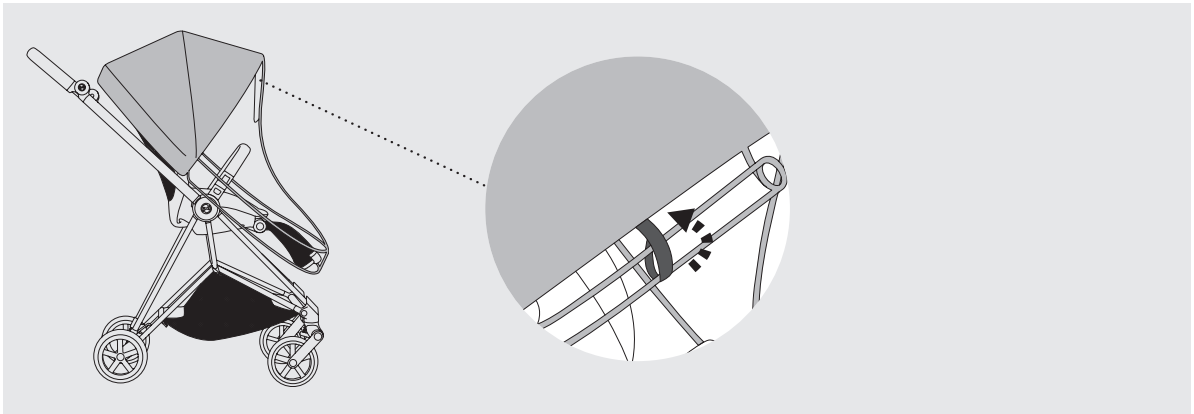

3

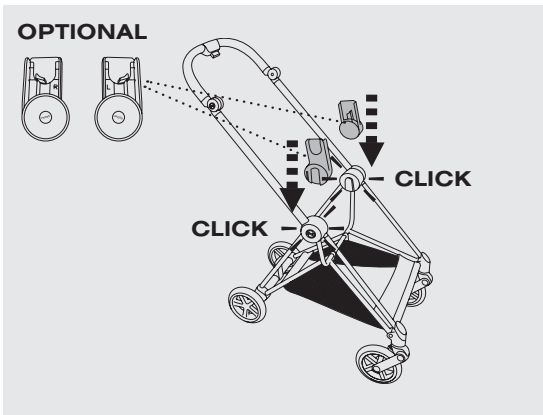

1



2

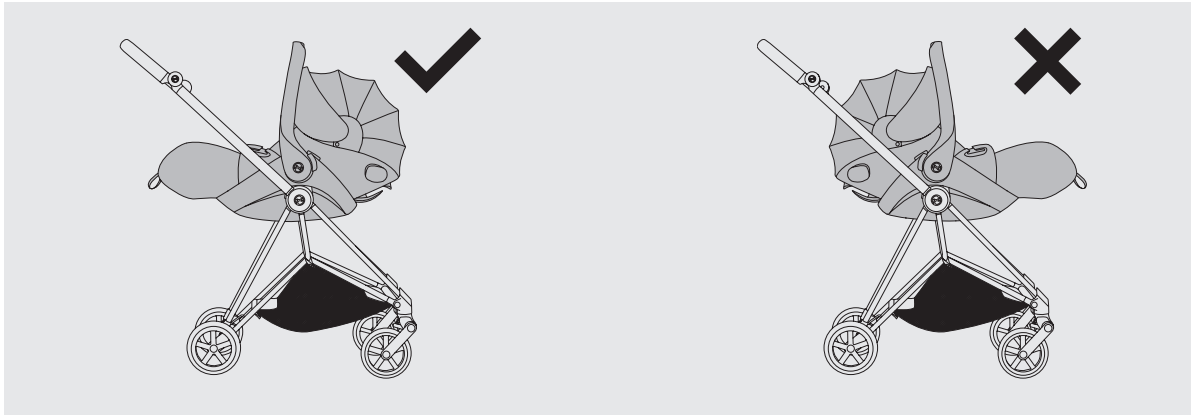

3

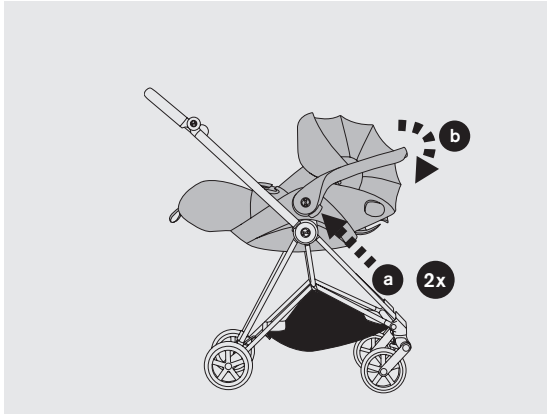

4

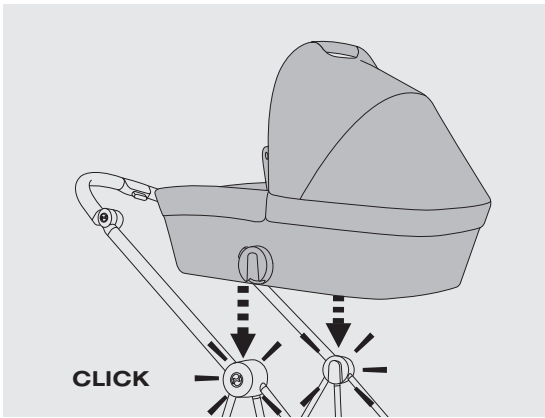
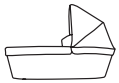

1

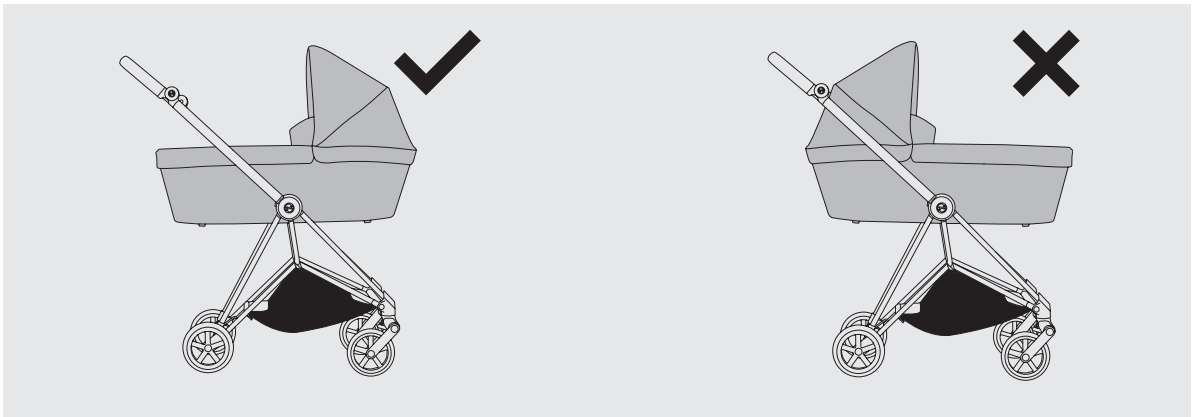

34

2

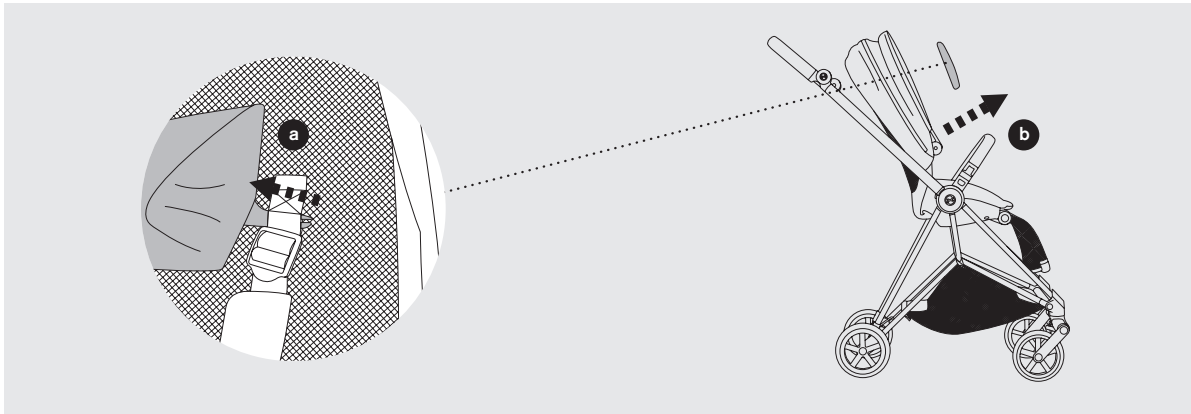

1

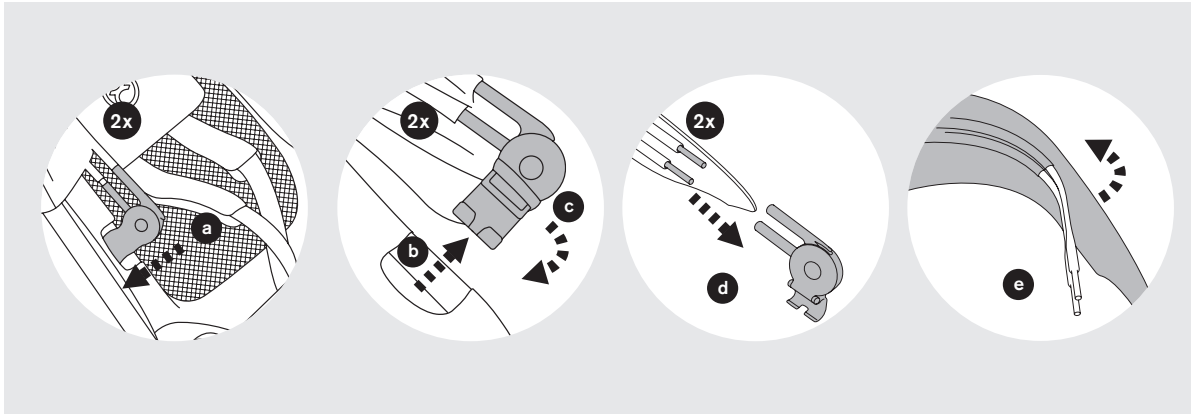

2



35

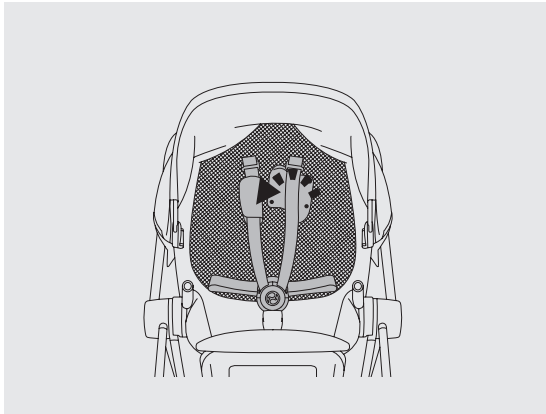

3

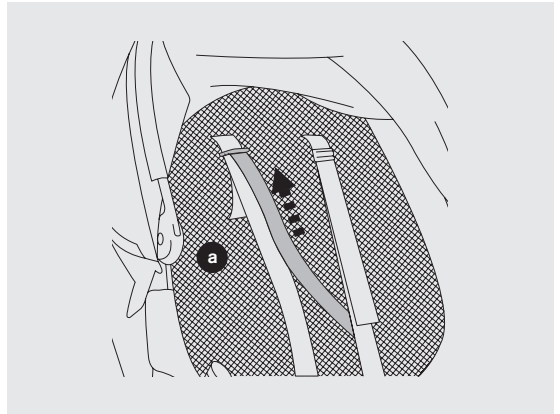

4

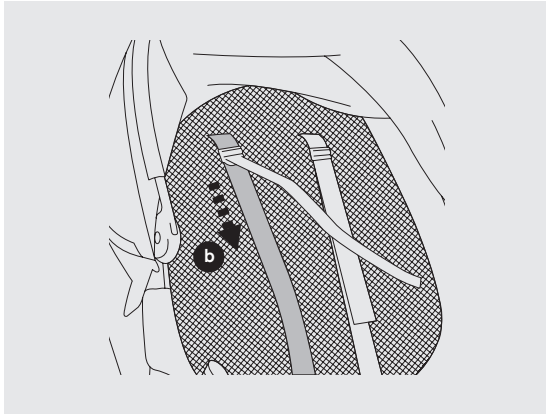

5

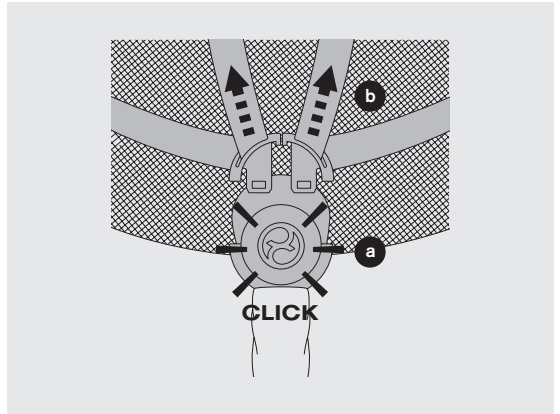

6

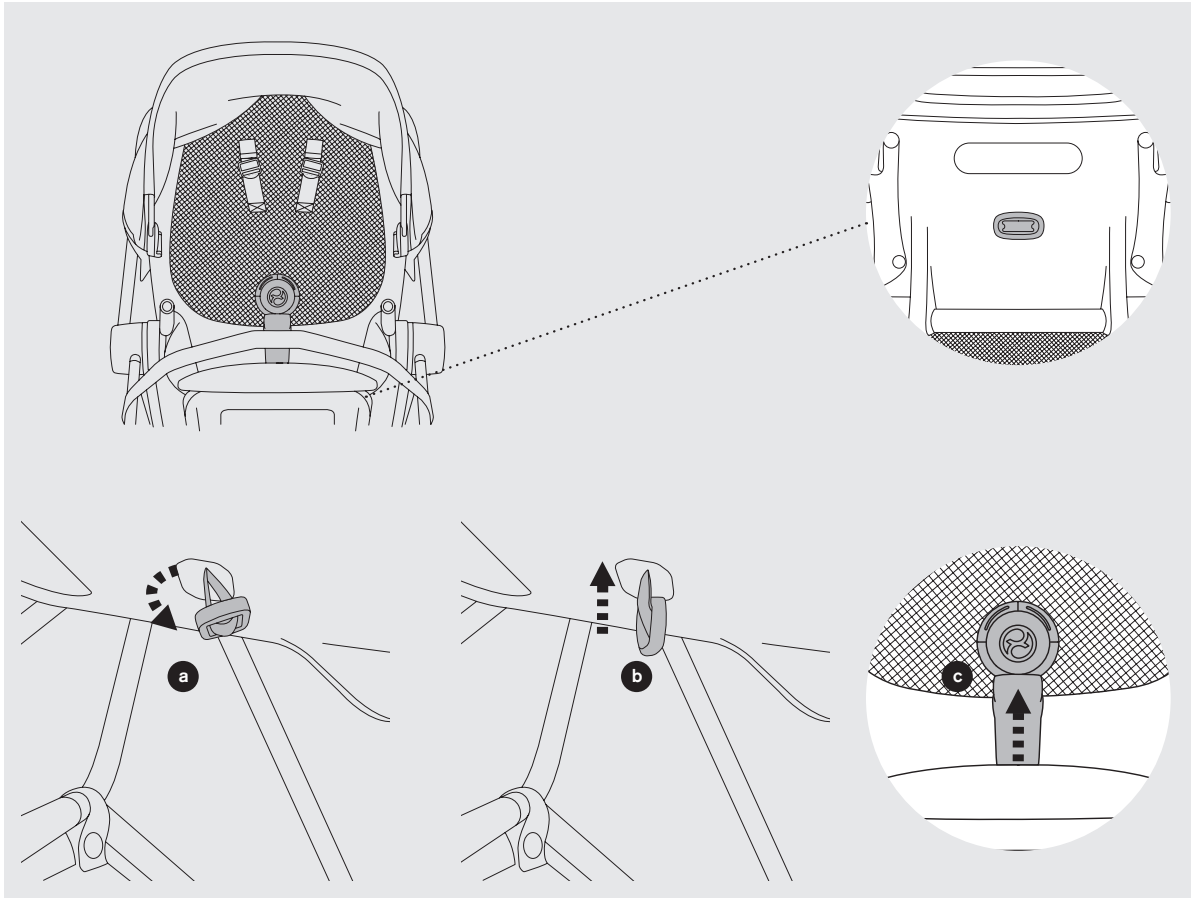

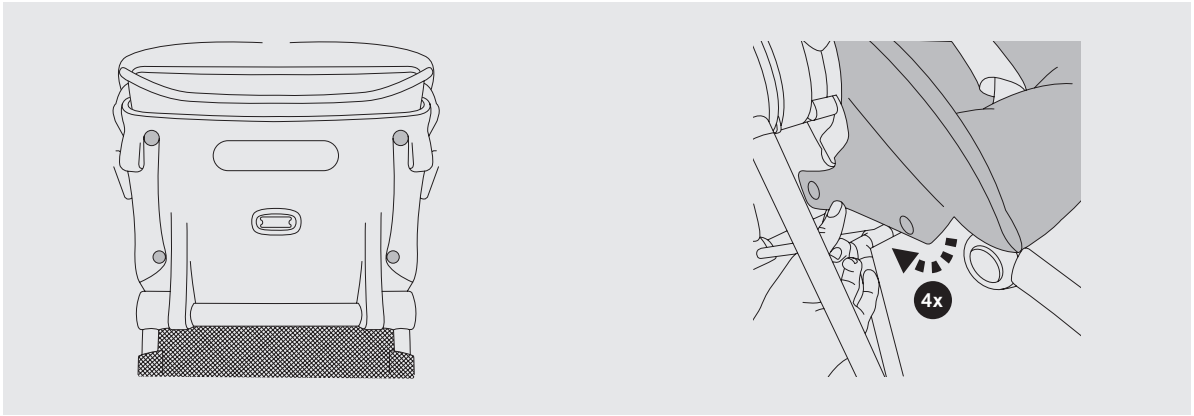

8

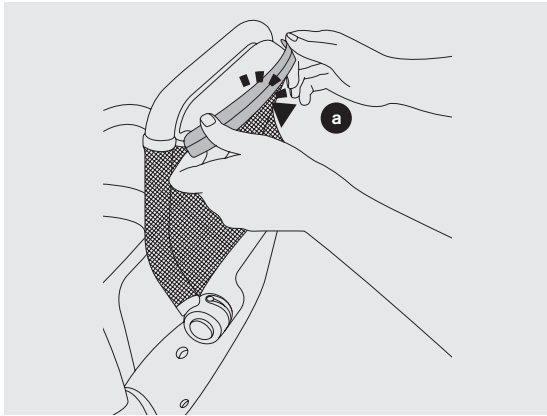

9

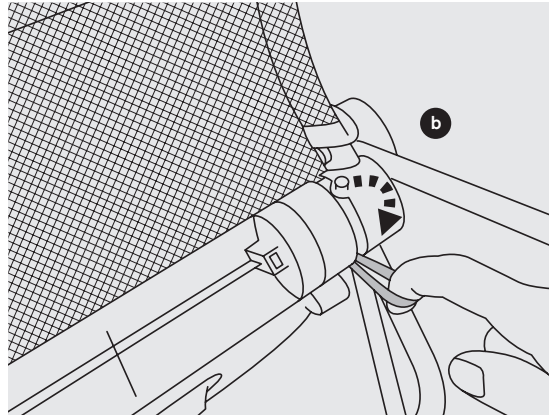

10

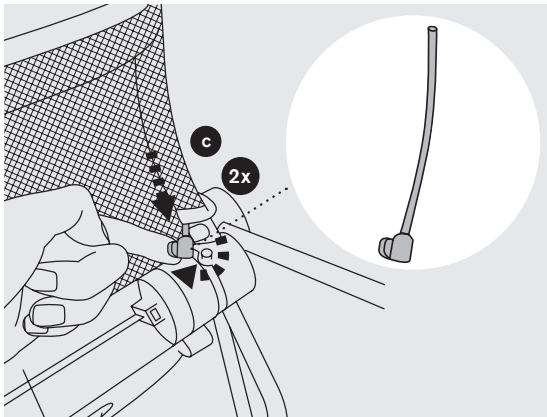

11

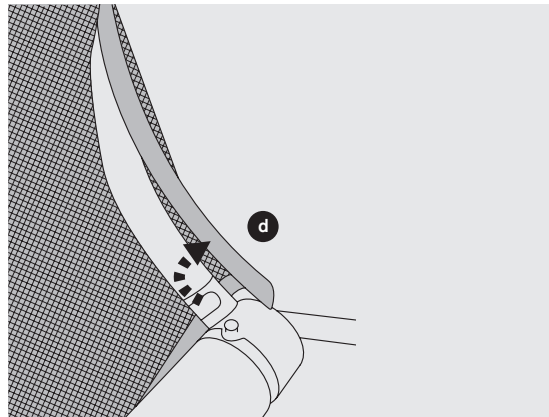

12

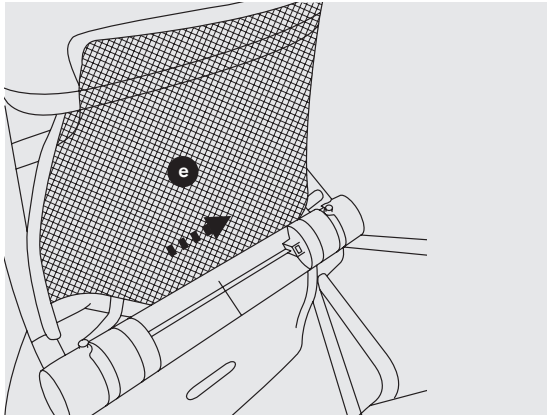

13

40

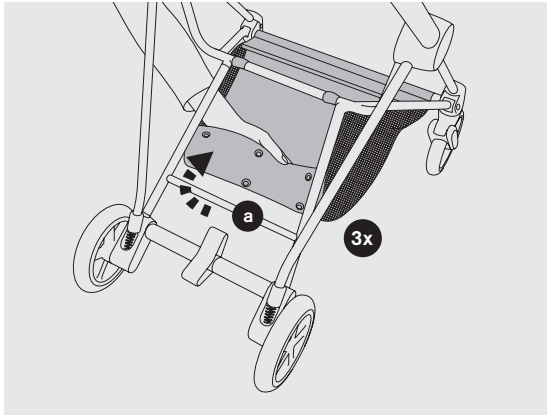

14

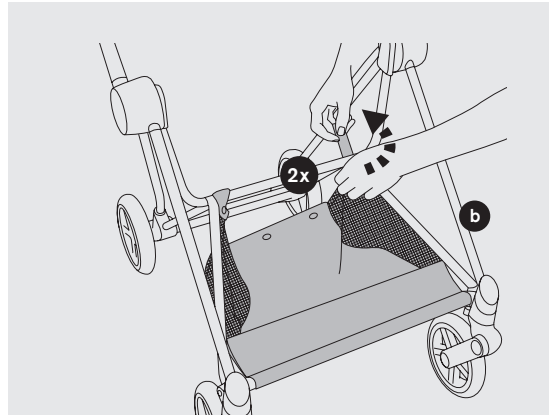

15

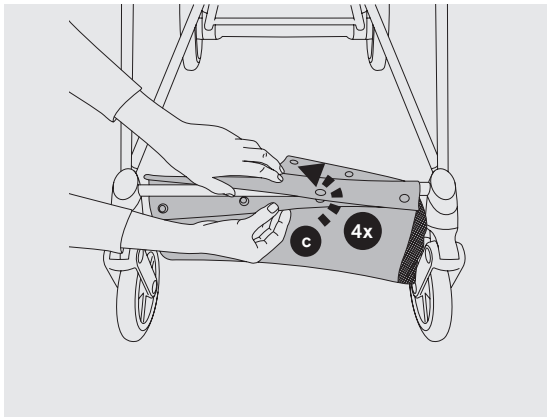

16

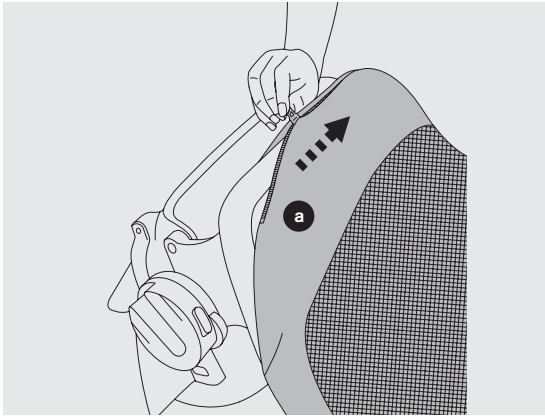

17

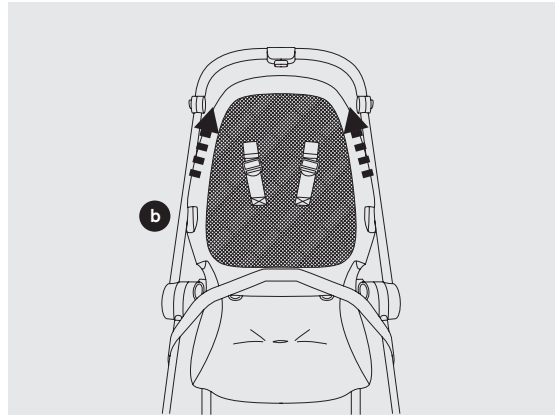

18

